

## Touchstone® TM604 Telephony Modem User's Guide

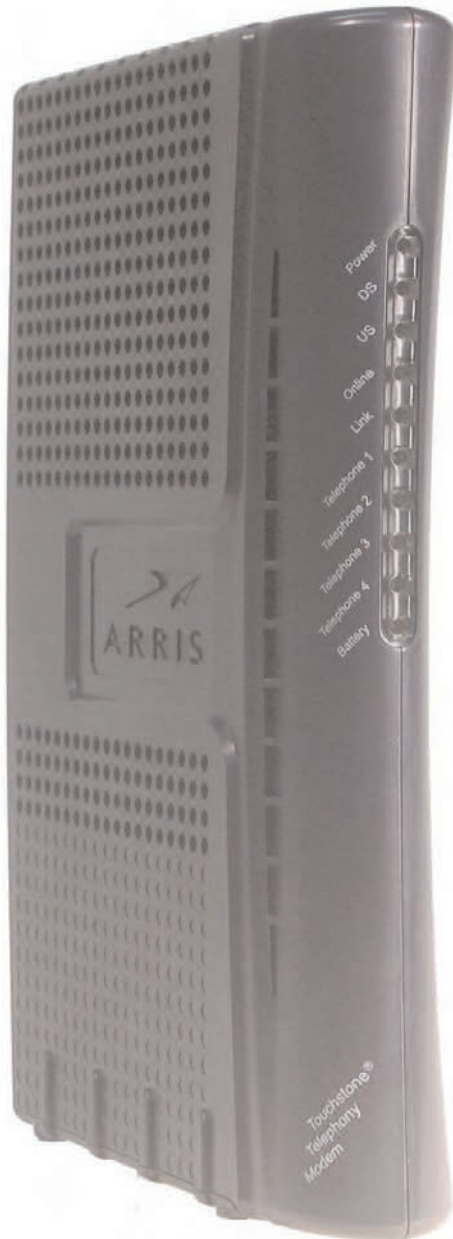

Get ready to experience the Internet's express lane! Whether you're checking out streaming media, downloading new software, checking your email, or talking with friends on the phone, the Touchstone TM604 Telephony Modem brings it all to you faster and more reliably. All while providing toll quality Voice over IP telephone service. Some models even provide a Lithium-Ion battery backup to provide continued telephone service during power outages.

The Touchstone Telephony Modem provides an Ethernet connection for use with either a single computer or home/office Local Area Network (LAN). In addition, the Touchstone Telephony Modem provides up to four separate lines of telephone service.

Installation is simple and your cable company will provide assistance to you for any special requirements. The links below provide more detailed instructions.

[Safety Requirements](#)

[Getting Started](#)

[Battery Installation and Replacement](#)

[Installing and Connecting Your Telephony Modem](#)

[Configuring Your Ethernet Connection](#)

[Using the Telephony Modem](#)

[Troubleshooting](#)

[Glossary](#)

## **Export Regulations**

This product may not be exported outside the U.S. and Canada without U.S. Department of Commerce, Bureau of Export Administration authorization. Any export or re-export by the purchaser, directly or indirectly, in contravention of U.S. Export Administration Regulation is prohibited.

Copyright © 2005–2010 ARRIS. All rights reserved.

The information in this document is subject to change without notice. The statements, configurations, technical data, and recommendations in this document are believed to be accurate and reliable, but are presented without express or implied warranty. Users must take full responsibility for their applications of any products specified in this document. The information in this document is proprietary to ARRIS.

ARRIS, Touchstone, and the ARRIS logo are trademarks or registered trademarks of ARRIS. All other trademarks and registered trademarks are the property of their respective holders.

Protected under one or more of the following U.S. patents: 7,031,435; 7,100,011. Other patents pending.

ARSVD01097

Release 6 Standard 1.3 February 2010

## Safety Requirements

ARRIS Telephony Modems comply with the applicable requirements for performance, construction, labeling, and information when used as outlined below:

**CAUTION****Risk of shock**

Mains voltages inside this unit. No user serviceable parts inside. Refer service to qualified personnel only!

**CAUTION****Potential equipment damage  
Potential loss of service**

Connecting the Telephony Modem to existing telephone wiring should only be performed by a professional installer. Physical connections to the previous telephone provider must be removed and the wiring must be checked; there must not be any voltages. Cancellation of telephone service is not adequate. Failure to do so may result in loss of service and/or permanent damage to the Telephony Modem.

**CAUTION****Risk of explosion**

Replacing the battery with an incorrect type can cause product failure and a risk of battery explosion. Dispose of used batteries according to the instructions.

- The Telephony Modem is designed to be connected directly to a telephone.
- Connecting the Telephony Modem to the home's existing telephone wiring should only be performed by a professional installer.
- Do not use product near water (i.e. wet basement, bathtub, sink or near a swimming pool, etc.), to avoid risk of electrocution.
- Do not use spray cleaners or aerosols on the Telephony Modem.

- Avoid using and/or connecting the equipment during an electrical storm, to avoid risk of electrocution.
- Do not use the telephone to report a gas leak in the vicinity of the leak.
- Do not locate the equipment within 6 feet (1.9 m) of a flame or ignition source (i.e. heat registers, space heaters, fireplaces, etc.).
- Use only the power supply and power cord included with the equipment.
- Equipment should be installed near the power outlet and should be easily accessible.
- The shield of the coaxial cable must be connected to earth (grounded) at the entrance to the building in accordance with applicable national electrical installation codes. In the U.S., this is required by NFPA 70 (National Electrical Code) Article 820. In the European Union and in certain other countries, CATV installation equipotential bonding requirements are specified in IEC 60728-11, *Cable networks for television signals, sound signals and interactive services, Part 11: Safety*. This equipment is intended to be installed in accordance with the requirements of IEC 60728-11 for safe operation.

If the equipment is to be installed in an area serviced by an IT power line network, as is found in many areas of Norway, special attention should be given that the installation is in accordance with IEC 60728-11, in particular Annex B and Figure B.4.

- In areas of high surge events or poor grounding situations and areas prone to lightning strikes, additional surge protection may be required (i.e. PF11VNT3 from American Power Conversion) on the AC, RF, Ethernet and Phone lines.
- When the Telephony Modem is connected to a local computer, the computer must be properly grounded to the building/residence AC ground network. All plug-in cards within the computer must be properly installed and grounded to the computer frame per the manufacturer's specifications.

## FCC Part 15

This equipment has been tested and found to comply with the requirements for a Class B digital device under Part 15 of the Federal Communications Commission (FCC) rules. These requirements are intended to provide reasonable protection against harmful interference in a residential installation. This equipment generates, uses and can radiate radio frequency energy and, if not installed and used in accordance with the instructions, may cause harmful interference to radio communications. However, there is no guarantee that interference will not occur in a particular installation. If this equipment does cause harmful interference to radio or television reception, which can be determined by turning the equipment off and on, the user is encouraged to try to correct the interference by one or more of the following measures:

- Reorient or relocate the receiving antenna.
- Increase the separation between the equipment and receiver.
- Connect the equipment into an outlet on a circuit different from that to which the receiver is connected.
- Consult the dealer or an experienced radio/TV technician for help.

Changes or modifications to this equipment not expressly approved by the party responsible for compliance could void the user's authority to operate the equipment.

## European Compliance

This product complies with the provisions of the Electromagnetic Compatibility (EMC) Directive (89/336/EEC), the Amending Directive (92/31/EEC), the Low Voltage Directive (73/23/EEC), and the CE Marking Directive (93/68/EEC). As such, this product bears the CE marking in accordance with the above applicable Directive(s).

A copy of the Declaration of Conformity may be obtained from: ARRIS International, Inc., 3871 Lakefield Drive, Suite 300, Suwanee, GA 30024.

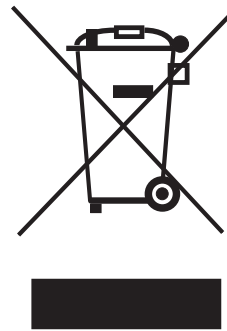

As indicated by this symbol, disposal of this product or battery is governed by Directive 2002/96/EC of the European Parliament and of the Council on waste electrical and electronic equipment (WEEE). WEEE could potentially prove harmful to the environment; as such, upon disposal of the Telephony Modem the Directive requires that this product must not be disposed as unsorted municipal waste, but rather collected separately and disposed of in accordance with local WEEE ordinances.

This product complies with directive 2002/95/EC of the European Parliament and of the Council of 27 January 2003 on the restriction of the use of certain hazardous substances (RoHS) in electrical and electronic equipment.

**ARRIS**  
RoHS Compliant  
**GREEN**

## Getting Started

### About Your New Telephony Modem

The Touchstone TM604 Telephony Modem is DOCSIS® compliant with the following features:

- Speed: much faster than dialup or ISDN service
- Convenience: supports Ethernet connections
- Flexibility: provides up to four independent lines of telephone service as well as high speed data
- Compatibility: supports tiered data services (if offered by your cable company)

### What's in the Box?

Make sure you have the following items before proceeding. Call your cable company for assistance if anything is missing.

- Telephony Modem
- Power Cord
- Quick Installation Guide
- Ethernet Cable
- Mini CD-ROM (80mm disc)
  - **Note:** An adapter is required for slot-loading drives. Adapter is not included.
- End User License Agreement

### What's on the CD?

The CD provides the following items:

- Quick Install Guide
- User's Guide
- Wall-Mount Template and Instructions

## Items You Need

If you are installing the Telephony Modem yourself, make sure you have the following items on hand before continuing:

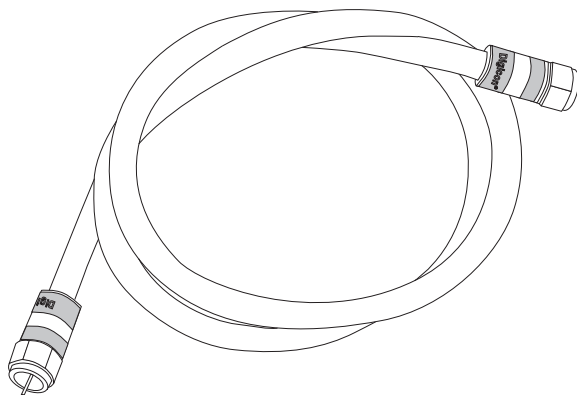

**Coax Cable**

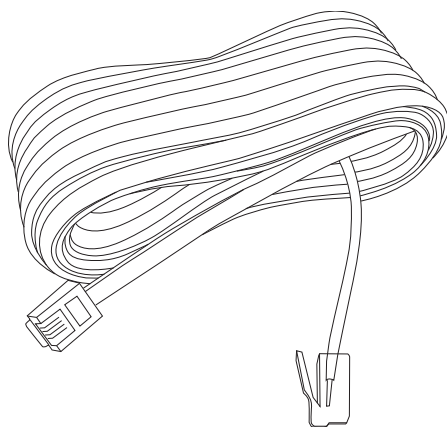

**Phone Cable**

- **Telephony modem package:** see What's in the Box? for a list of items in the package.
- **Coaxial cable (coax):** as shown in the image to the left, this is a thin cable with a connector on each end. It is the same kind of wire used to connect to your television for cable TV. You can buy coax from any electronics retailer and many discount stores; make sure it has connectors on both ends. There are two types of connectors, slip-on and screw-on; the screw-on connectors are best for use with your Telephony Modem. The coax should be long enough to reach from your Telephony Modem to the nearest cable outlet.
- **Phone Cable:** as shown in the image to the left, this is a standard phone cable with standard phone connectors (RJ11 type) on both ends. You can buy phone cables from any electronics retailer and many discount stores.
- **Splitter (optional):** provides an extra cable connection by splitting a single outlet into two. You may need a splitter if you have a TV already connected to the cable outlet that you want to use. You can buy a splitter from any electronics retailer and most discount stores; you may also need a short piece of coax cable (with connectors); use it to connect the splitter to the cable outlet and then connect the Telephony Modem and TV to the splitter.  
**Note:** A splitter effectively cuts the signal in half and sends each half to its two outputs. Using several splitters in a line may deteriorate the quality of your television, telephone, and/or internet connection.
- **Wall-mount hardware (optional):** if you want to wall-mount your Telephony Modem, you need to obtain two drywall anchors or wood screws. See the Wall-Mount Template and Instructions for more details.
- **Information packet:** your cable company should furnish you with a packet containing information about your service and how to set it up. Read this information carefully and contact your cable company if you have any questions.



## Getting Service

Before trying to use your new Telephony Modem, contact your local cable company to establish an Internet account and telephone service. When you call, have the following information ready:

- the Telephony Modem serial number and MAC addresses of the unit (printed on a sticker on the bottom of the Telephony Modem)
- the model number of the Telephony Modem

Save this information for future use. In addition, you should ask your cable company the following questions:

- Do you have any special system requirements or files that I need to download after I am connected?
- When can I start using my Telephony Modem?
- Do I need a user ID or password to access the Internet or my e-mail?
- Will my phone number(s) change?
- What new calling features will I have and how do I use them?

## System Requirements

The Touchstone Telephony Modem operates with most computers. The following describes requirements for each operating system; see the documentation for your system for details on enabling and configuring networking.

To use the Telephony Modem, you need DOCSIS high-speed Internet service from your cable company.

### Windows

Windows 98, Windows 98 SE (Second Edition), Windows ME, Windows 2000, Windows XP, Windows Vista, or Windows 7

### MacOS

System 7.5 to MacOS 9.2 (Open Transport recommended) or MacOS X

### Linux/other Unix

Hardware drivers, TCP/IP, and DHCP must be enabled in the kernel

## About this Manual

This manual covers all of the different TM604 models. Your model may not have all of the capabilities outlined in this manual. To determine which model you have purchased, refer to the image at the left. The model number is on the label affixed to the Telephony Modem.

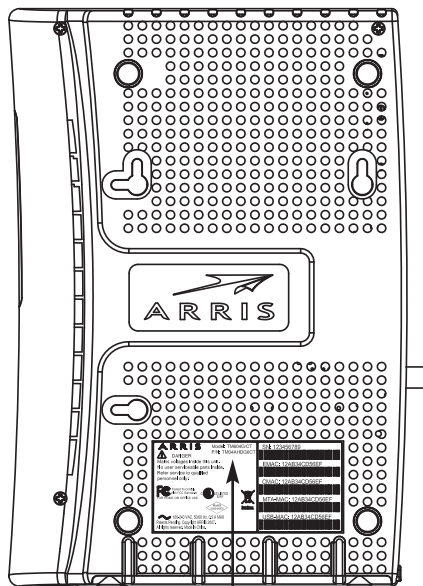

**Model Number**

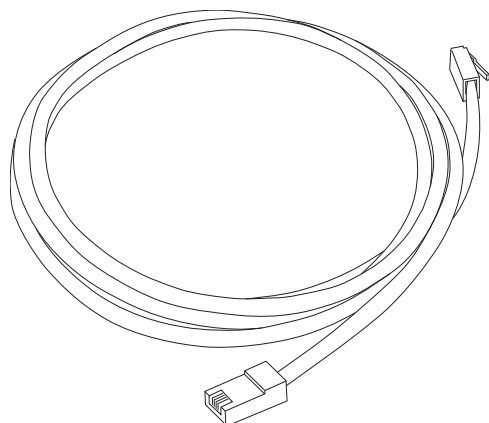
**Ethernet Cable**

## About the Ethernet Connection

Ethernet is a standard method of connecting two or more devices into a Local Area Network (LAN).

**Note:** To connect two or more computers to the Ethernet port, you will need a hub or broadband router (available at computer retailers).

The Telephony Modem package comes with a 6-foot (1.9m) Ethernet cable (the connectors look like wide telephone connectors); you can purchase more cables if necessary at a computer retailer. If you are connecting the Telephony Modem directly to a computer, or to an Ethernet hub or broadband router with a cross-over switch, use the included cable or ask for Category 5 (CAT5) straight-through cable. If you are connecting the Telephony Modem to an Ethernet hub or broadband router without a crossover switch, ask for a Category 5 crossover cable.

## What About Security?

Having a high-speed, always-on connection to the Internet requires a certain amount of responsibility to other Internet users—including the need to maintain a reasonably secure system. While no system is 100% secure, you can use the following tips to enhance your system's security:

- Keep your operating system updated with the latest security patches. Run the system update utility at least weekly.
- Keep your email program updated with the latest security patches. In addition, avoid opening email containing attachments, or opening files sent through chat rooms, whenever possible.
- Install a virus checker and keep it updated.
- Avoid providing web or file-sharing services over your Telephony Modem. Besides certain vulnerability problems, most cable companies prohibit running servers on consumer-level accounts and may suspend your account for violating your terms of service.
- Use the cable company's mail servers for sending email.

- Avoid using proxy software unless you are certain that it is not open for abuse by other Internet users (some are shipped open by default). Criminals can take advantage of open proxies to hide their identity when breaking into other computers or sending spam. If you have an open proxy, your cable company may suspend your account to protect the rest of the network.
- If you connect your Telephony Modem to a wireless LAN, make sure you enable security and encryption on the wireless hub (for the same reasons that you should run only secured proxies). Consult the documentation and technical support of the wireless equipment provider for help.

## Battery Installation and Replacement

Many Telephony Modem models support an optional Lithium-Ion backup battery. The TM604G supports the following battery models:

- **Extended backup battery** — provides up to 12 hours of backup time, depending on model and usage. It has a strap between the battery guides.



- **Maximum backup battery** — provides up to 24 hours of backup time, depending on model and usage. It replaces the battery door, and increases the height of the Telephony Modem by about 5/8 inch (16 mm).



Your cable company may include a backup battery with your Telephony Modem. You can order any of the batteries shown here at <http://yourbroadbandstore.com/>

## Extended Backup Battery Installation

- 1 Pull back the battery door latch and remove the battery door. Set the door aside.

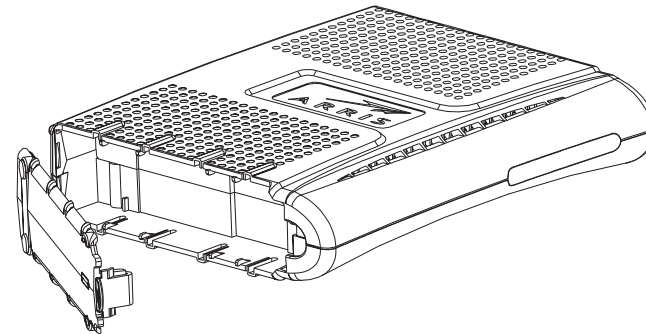

- 2 Stand the Telephony Modem on its top, so the battery bay faces up.
- 3 Align the guides on the battery with the slots on the Telephony Modem as shown below, and slide the battery into the bay.

**Note:** Batteries will not insert completely into the Telephony Modem if not oriented correctly. The battery should slide into the bay without significant force. Line up the slots in the battery bay with the guides on the battery and apply even pressure on both ends of the battery.

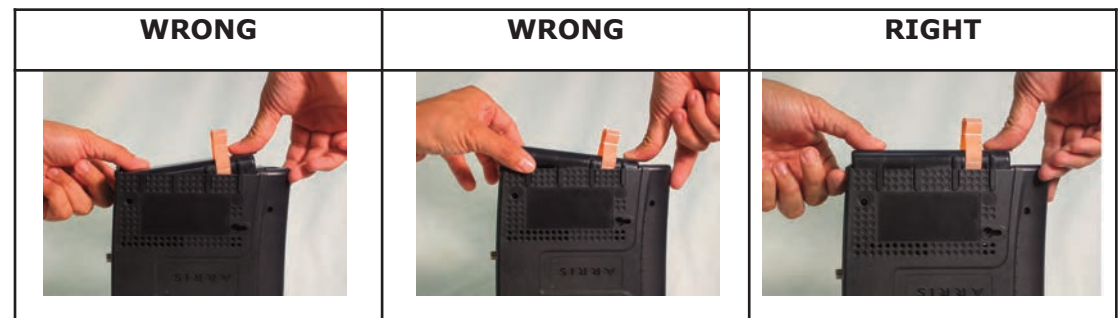

- 4 Replace the battery door: insert the hinge tabs in the receiver slots, and close the door until the latch snaps into place.

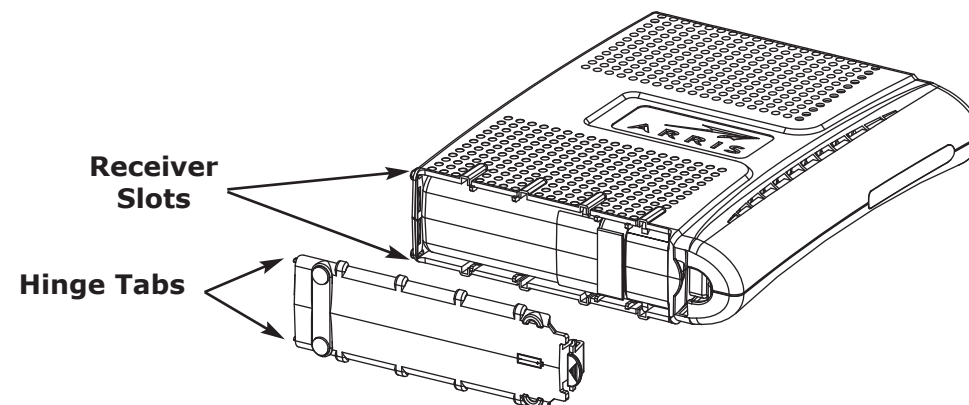

## Maximum Backup Battery Installation

- 1 Pull back the battery door latch and remove the battery door. The Maximum Backup battery replaces the door; store the door in a safe place.

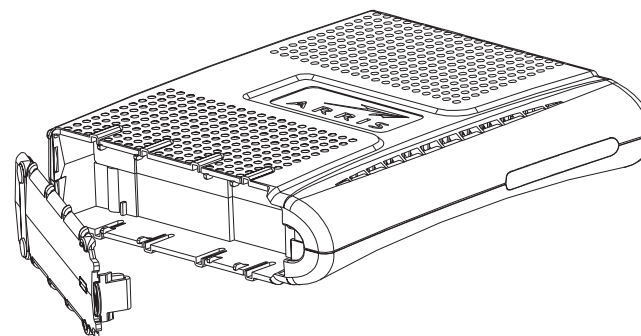

- 2 Place the battery on a firm horizontal surface.

- 3 Position the Telephony Modem over the battery, aligning the slots on the battery bay with the tabs on the battery. Push straight down on the Telephony Modem until the battery latch clicks into place.

**Note:** You may need to push down gently on the front of the Telephony Modem to latch the battery into place.

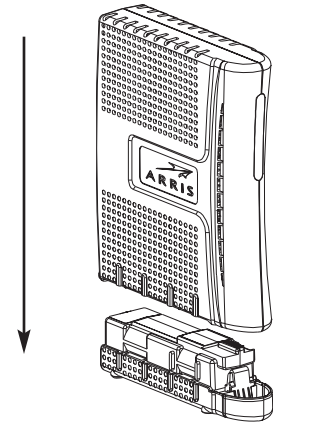



## Extended Backup Battery Removal

- 1 Pull back the battery door latch and remove the battery door. Set the door aside.
- 2 Pull the strap until the battery disconnects and slides out of the bay.

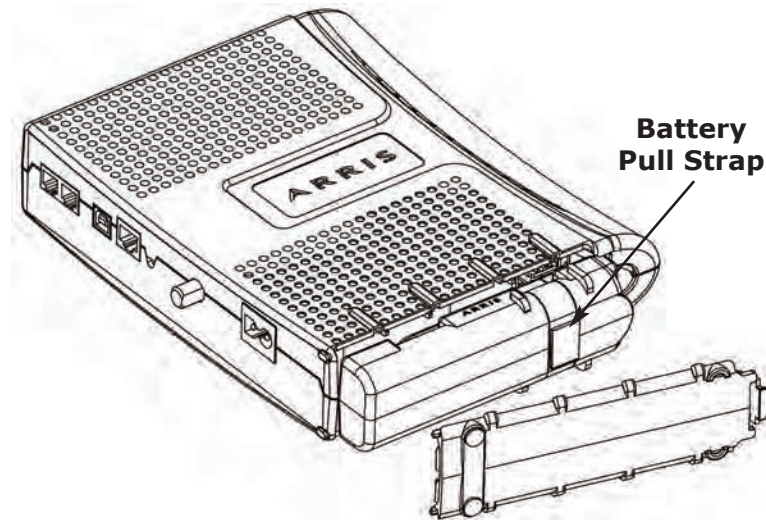

## Maximum Backup Battery Removal

- 1 Grasp the battery and pull back on the latch at the front of the battery.

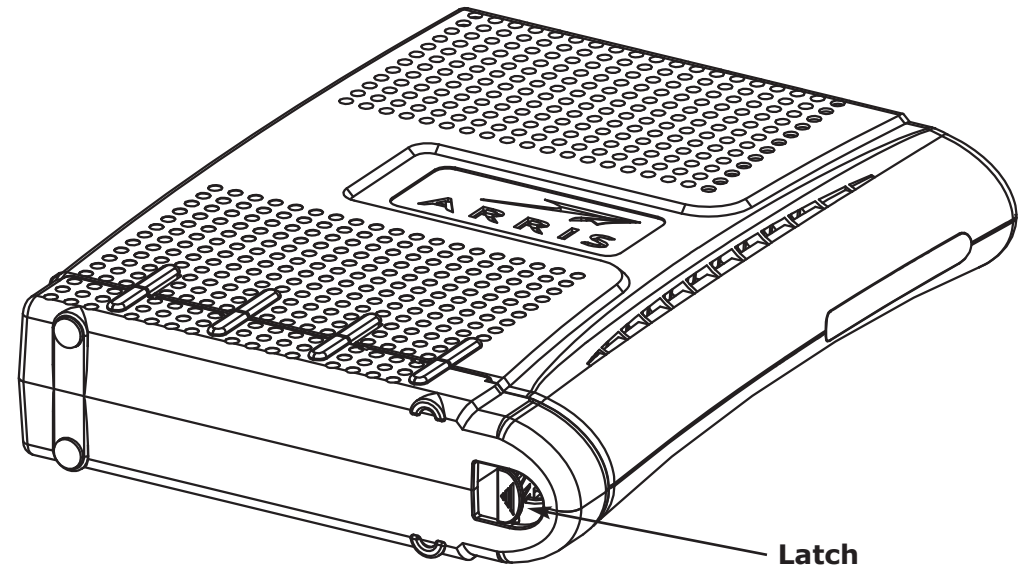

- 2 Gently rock the battery out of the bay.

## Installing and Connecting Your Telephony Modem

Before you start, make sure that:

- You have contacted your cable company and verified that they provide data and telephone service using standard DOCSIS technology.
- You have all the [Items You Need](#).
- Cable, phone, and power outlets are available near the computer. If a cable outlet is not conveniently located, your cable company can install a new one.

If you have ordered service, your cable company should configure the Telephony Modem automatically. You need only follow the instructions in this section to install and connect the Telephony Modem.



### CAUTION

#### Risk of equipment damage

Only qualified installation technicians should connect the Telephony Modem to house wiring. Incumbent telephone service must be *physically* disconnected at the outside interface box before making any connections.

---

## Front Panel

The front of the Telephony Modem provides the following indicators.

The front of the Telephony Modem has the following indicators:

- A Battery:** indicates status of the battery in the Telephony Modem
- B Telephone 1-4:** indicates the status of each telephone line
- C Link:** indicates Ethernet connectivity between the Telephony Modem and computer
- D Online:** indicates internet data transmission status
- E US:** indicates upstream connectivity
- F DS:** indicates downstream connectivity
- G Power:** indicates whether AC power is available to the unit

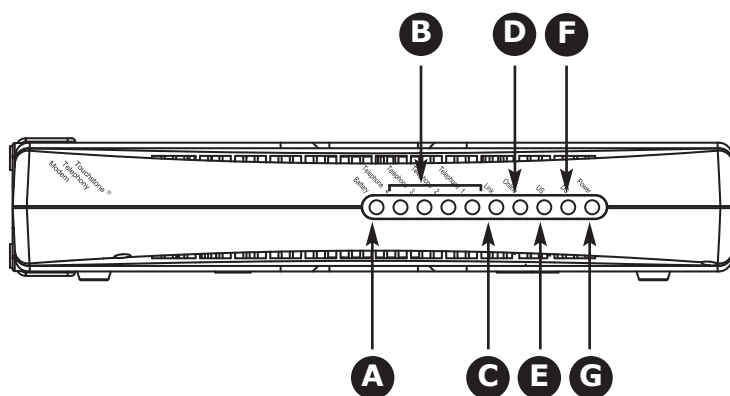

## Rear Panel

The rear of the Telephony Modem has the following connectors and controls:

- A Tel 1-4 (grey):** connectors for the phone lines. Lines 1 and 3 are marked "Line 1/2" and "Line 3/4," which means they accommodate both lines of a 2-line phone.
- B Ethernet connector (yellow):** for use with a computer or home network LAN connection.
- C Reset button:** resets the Telephony Modem as if you power cycled the unit. Use a pointed **non-metallic** object to press this button.
- D Cable:** connector for the [coax cable](#).
- E Power:** connector for the power cord.

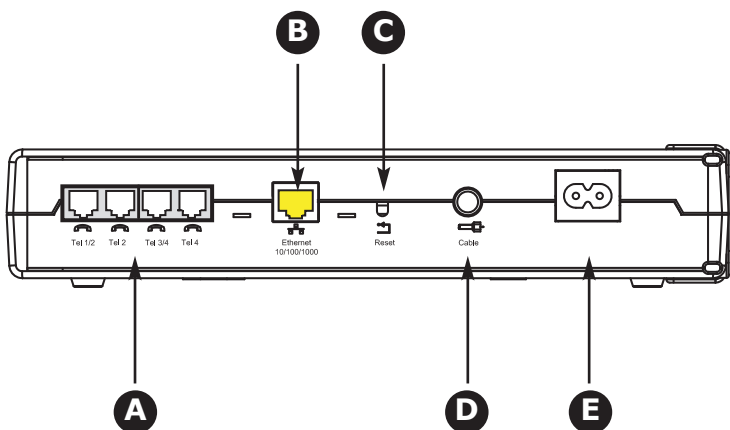

## Mounting the Telephony Modem

You can either mount the Telephony Modem on a wall or place it on a desktop. For wall-mount applications, you can mount the Telephony Modem with the indicators facing upward (vertical) or to the side (horizontal).

### Tools and Materials

For wall-mounted installations, make sure you have the following tools and materials before proceeding:

- for mounting on drywall: Two 1/4" (6mm) drywall anchors and a drill with 1/4" (6mm) bit (not included)
- for mounting on plywood or studs: two #6 x 1.5" (38.1 mm) self tapping screws (not included)
- screwdriver (flat-blade or Phillips, depending on what kind of screws you use)
- wall-mount template (included)
- transparent tape: for temporarily securing the mounting template to the wall (not included)

### Location

Always position the Telephony Modem:

- within reach of an AC outlet. The power cord must reach the outlet without stretching and without adding extension cords.
- near a cable outlet (to avoid long cable runs).

**Note:** If your Telephony Modem has the maximum backup battery installed, wall-mount the Telephony Modem horizontally, with the battery side facing the floor.



Step 1

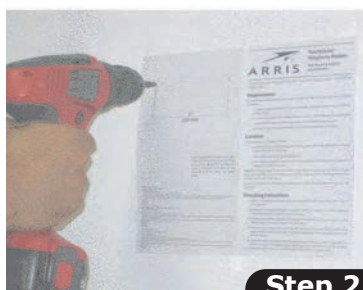

Step 2

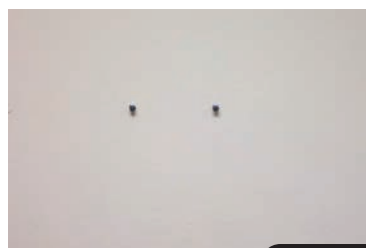

Step 3



Step 4

## Instructions

### Wall-mounting instructions

**Note:** When mounting the Telephony Modem on drywall, try to position the Telephony Modem so at least one of the screws are fastened to a stud. This may prevent the Telephony Modem from pulling out of the wall in the future.

To prevent overheating of the Telephony Modem, do not block the ventilation holes on the sides of the unit.

- 1 Position the mounting template on the surface where you intend to mount the Telephony Modem and secure in place with transparent tape.
- 2 Drill holes through the template in the specified locations for the mounting screws. After drilling holes, remove the template from the surface.
- 3 If using drywall anchors, set them into the wall. Then, drive the screws into the wall leaving a gap of about 1/8" (3 mm) between the screw head and the wall. If not using anchors, just drive the screws.
- 4 Orient the Telephony Modem with the indicator lights facing up or right, as desired. Slip both mounting slots (in the back of the Telephony Modem) over the screws, then slide the case down until the narrow end of the keyhole slot contacts the screw shaft.
- 5 Proceed to [Connecting the Telephony Modem](#).

### Desktop mounting instructions

- 1 Position the Telephony Modem so that:
  - air flows freely around it
  - the back faces the nearest wall
  - it will not fall to the floor if bumped or moved
- 2 Proceed to [Connecting the Telephony Modem](#).

## Connecting the Telephony Modem



### WARNING

#### Risk of injury or equipment damage

Connecting the Telephony Modem to the home's existing telephone wiring should only be performed by a professional installer. Physical connections to the previous telephone provider must be removed and the wiring must be checked; there must not be any voltage. Cancellation of telephone service is not adequate. Failure to do so may result in loss of service and/or permanent damage to the Telephony Modem.

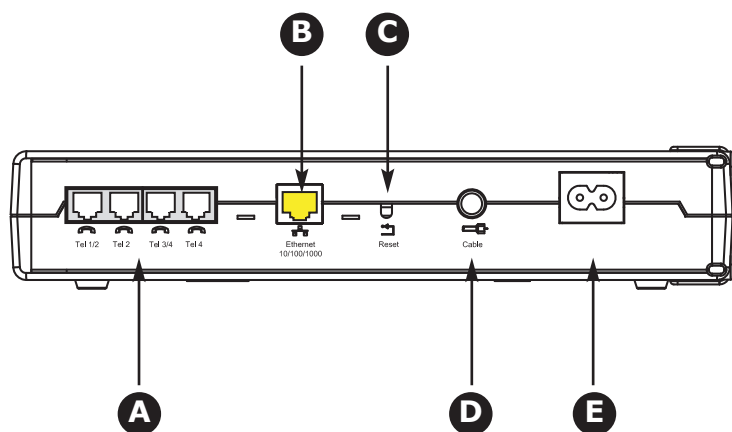

- 1 Connect one end of the coax cable to the cable outlet or splitter, and the other end to the Telephony Modem's Cable connector (**D**). Tighten the connections by hand, then tighten an additional 1/8 turn with a wrench.

**Note:** For best results, use high-quality RG-6 type coax cable, cut to the minimum practical length to minimize losses. The HFC network must be DOCSIS 2.0 compatible.

- 2 Insert the plug from the power cord into the Power connector on the Telephony Modem (**E**) and insert the power cord into a convenient AC outlet.

*The Power light on the front of the Telephony Modem lights up, then flashes once (refer to the LED table on page 40). See [Troubleshooting](#) if the Power light does not turn on.*

- 3 Connect one end of the Ethernet cable to the yellow port on the back of the Telephony Modem labeled "Ethernet 10/100," (**B**) and the other end to the Ethernet port on a computer, hub, or broadband router.

**Note:** If you are connecting to a computer, use the Ethernet cable included in the Telephony Modem package.

- 4 Connect one end of the telephone cable to one of the grey telephone ports on the back of the Telephony Modem (**A**). Connect the other end to the telephone.

**Note:** If you have a phone with two separate lines on a single RJ-14 cord, it must be plugged into the port labeled "Tel 1/2" or "Tel 3/4."

## Configuring Your Ethernet Connection

If your computer is equipped with a LAN card providing an Ethernet connection, you may have to configure your computer's TCP/IP settings. The steps that follow will guide you through setting your computer's TCP/IP settings to work with the Telephony Modem.

### Requirements

Make sure you have the following before attempting to configure your Ethernet connection:

- Computer with:
  - one of: Windows 98SE, Windows 2000, Windows ME, Windows XP, Windows Vista, Windows 7, or MacOS X
  - Ethernet interface
- Ethernet cable (supplied)
- IP address, subnet, gateway, and DNS information for installations not using DHCP

### How to use this chapter

The following list shows the procedures for modifying the TCP/IP settings on the computer. The procedure is slightly different depending on the operating system that you are using. Please ensure you are using the correct steps for the operating system on your computer. Follow the links below for instructions to configure your ethernet connection on your operating system.

- [TCP/IP Configuration for Windows 98SE](#)
- [TCP/IP Configuration for Windows 2000](#)
- [TCP/IP Configuration for Windows ME](#)
- [TCP/IP Configuration for Windows XP](#)
- [TCP/IP Configuration for Windows Vista](#)
- [TCP/IP Configuration for Windows 7](#)
- [TCP/IP Configuration for MacOS X](#)



## TCP/IP Configuration for Windows 98SE

Follow these steps to configure the TCP/IP settings on a Windows 98SE operating system.

**Note:** Dialog boxes shown on your computer may differ slightly from those shown in this procedure.

- 1 From the computer, select **Start > Settings > Control Panel**.
- 2 Double click on the **Network** icon in the Control Panel.



- 3 Click the **Configuration** tab in the Network window to display the list of Network Adapters.

- 4 Highlight **TCP/IP** by clicking on it one time, then click on **Properties**.

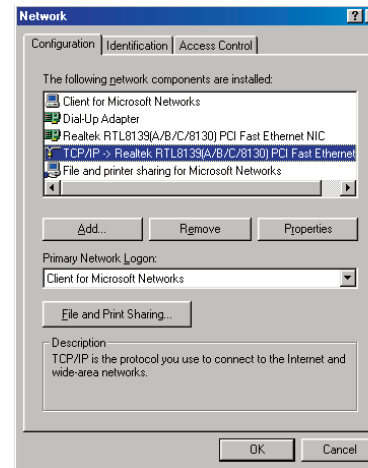

- 5 Click the **IP Address** tab, click **Obtain an IP address automatically**, then click **OK**.

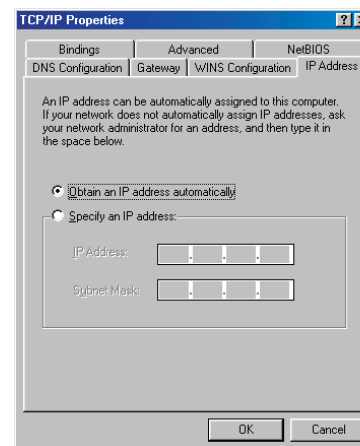

- 6 Click **OK** to accept the new settings, and **OK** again to close the Configuration window.
- 7 You may have to restart your computer in order for your computer to obtain a new IP address from the network.

## TCP/IP Configuration for Windows 2000

Follow these steps to configure the TCP/IP settings on a Windows 2000 operating system.

**Note:** Dialog boxes shown on your computer may differ slightly from those shown in this procedure.

- 1 From the computer, select **Start > Settings > Network and Dial-up Connections > Local Area Connection**.
- 2 In the Local Area Connections Properties window, highlight **TCP/IP** by clicking on it one time, then click on **Properties**.

**Note:** If your computer has more than one Ethernet card, you may have to select the appropriate Ethernet card in the **Connect using:** area of the Local Area Connection Properties window.

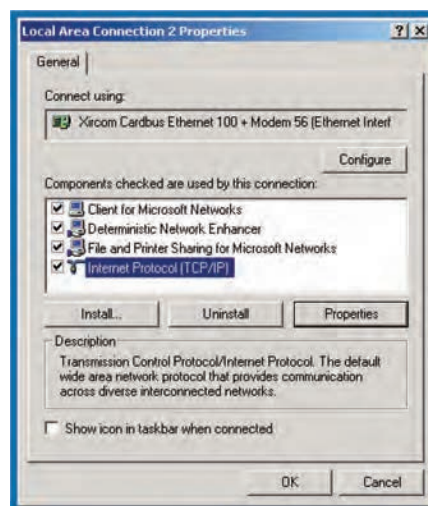

- 3 Click **Obtain an IP address automatically** and **Obtain DNS server address automatically**, then click **OK**.

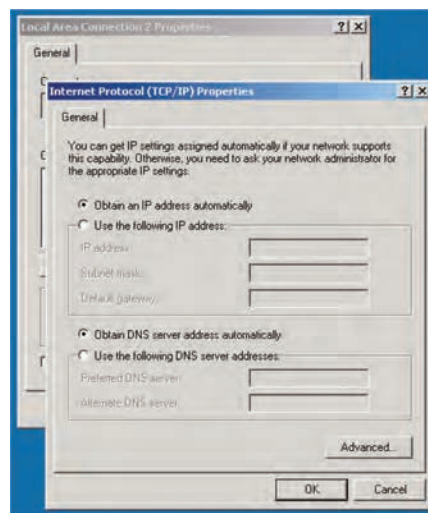

- 4 Click **OK** to accept the new settings, and **OK** again to close the Configuration window.
- 5 You may have to restart your computer in order for your computer to obtain a new IP address from the network.

## TCP/IP Configuration for Windows ME

Follow these steps to configure the TCP/IP settings on a Windows ME operating system.

**Note:** Dialog boxes shown on your computer may differ slightly from those shown in this procedure.

- 1 From the computer, select **Start > Settings > Control Panel**.
- 2 Double click on the **Network** icon in the Control Panel.

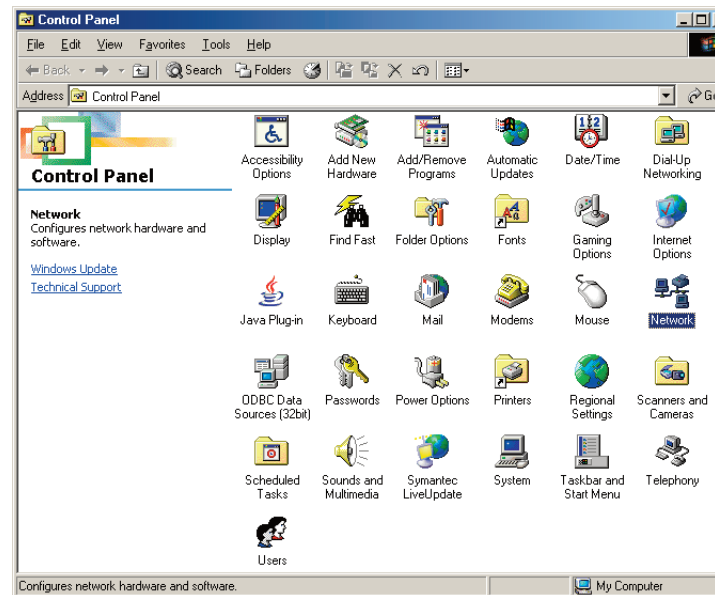

- 3 Click the **Configuration** tab in the Network window to display the list of Network Adapters.

- 4 Highlight **TCP/IP** by clicking on it one time, then click on **Properties**.

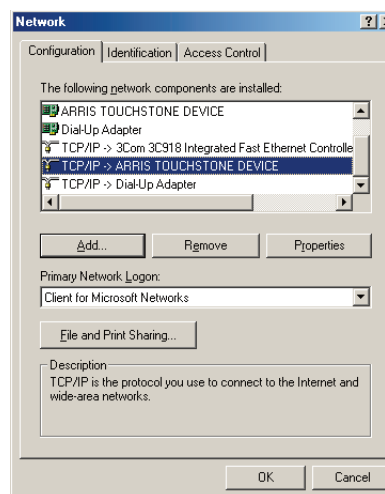

- 5 Click the **IP Address** tab, then click **OK**.

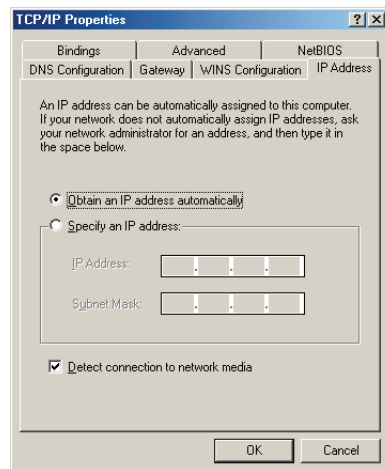

- 6 Click **OK** to accept the new settings, and **OK** again to close the Configuration window.
- 7 You may have to restart your computer in order for your computer to obtain a new IP address from the network.

## TCP/IP Configuration for Windows XP

Follow these steps to configure the TCP/IP settings on a Windows XP operating system.

**Note:** Dialog boxes shown on your computer may differ slightly from those shown in this procedure.

- 1 From the computer, select **Start > Settings > Control Panel** and double click on the **Network Connections** icon in the Control Panel.
- 2 Click the **Configuration** tab in the Network window to display the list of Network Adapters.

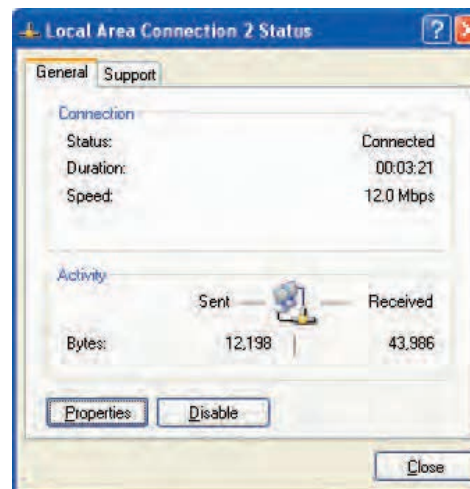

- 3 Highlight **TCP/IP** by clicking on it one time, then click on **Properties**.

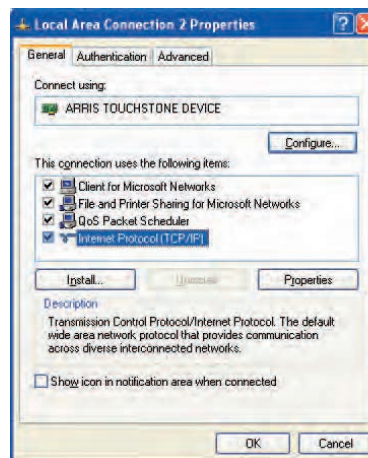

- 4 Click the **IP Address** tab, click **Obtain an IP address automatically**, then click **OK**.

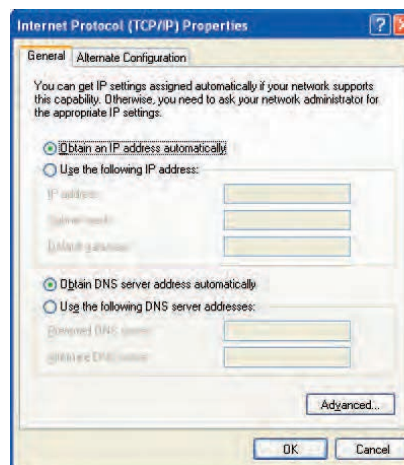

- 5 Click **OK** to accept the new settings, and **OK** again to close the Configuration window.
- 6 You may have to restart your computer in order for your computer to obtain a new IP address from the network.



## TCP/IP Configuration for Windows Vista

Follow these steps to configure the Ethernet interface for use with Touchstone products.

- 1 Open the Vista Control Panel.

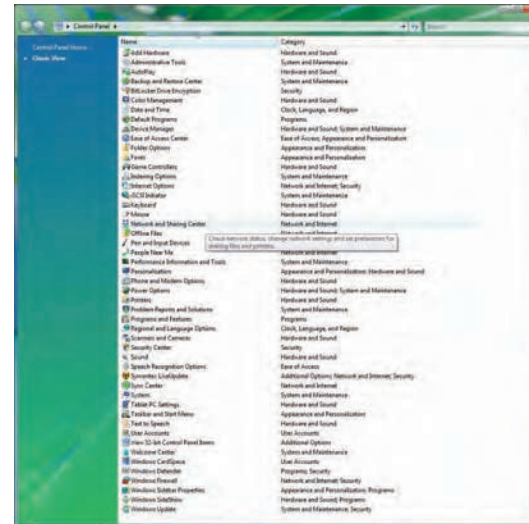

- 2 Double-click **Network and Sharing Center**.

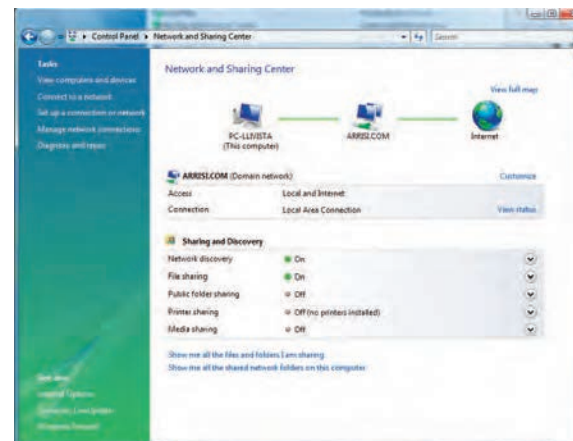

- 3 Click **Manage network connections**. If prompted for a connection, choose **Local Area Connection**.

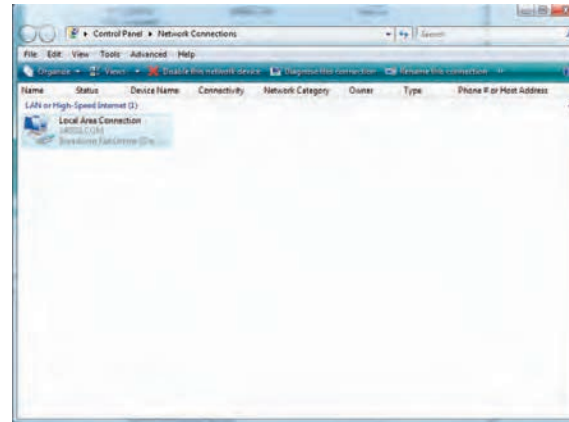

- 4 Double-click the **Local Area Connection** to open the Status window:

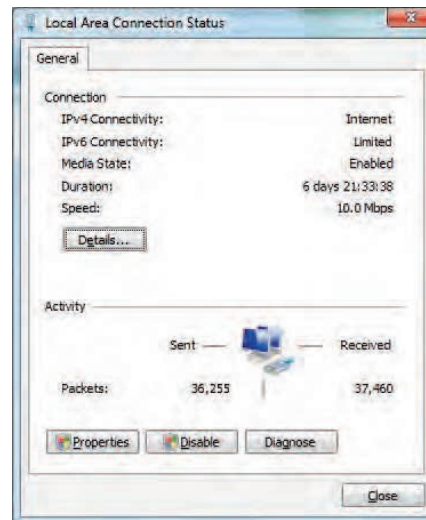

- 5 If Windows requests permission to continue, click **Continue**.
- 6 Click **Properties**.

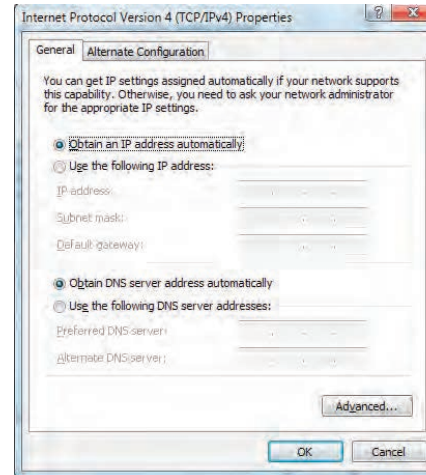
**7** Double-click **Internet Protocol Version 4 (TCP/IPv4)**.

- 8** Select **Obtain an IP address automatically** and **Obtain DNS server address automatically**, unless instructed otherwise by your cable provider.
- 9** Click **OK** to close the Properties windows.

## TCP/IP Configuration for Windows 7

Follow these steps to configure the Ethernet interface for use with Touchstone products.

- 1 Open the Windows 7 Control Panel.



- 2 Click **Network and Internet**.

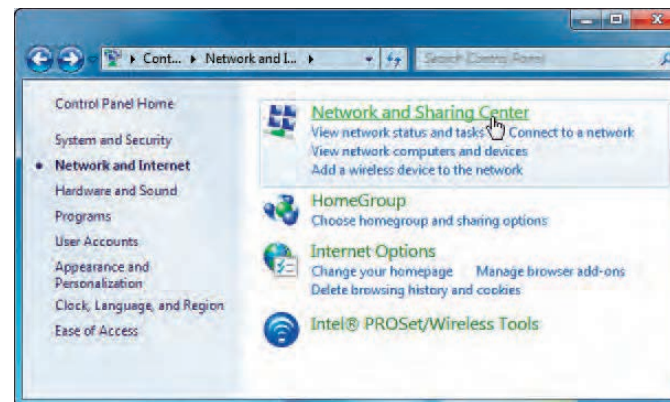

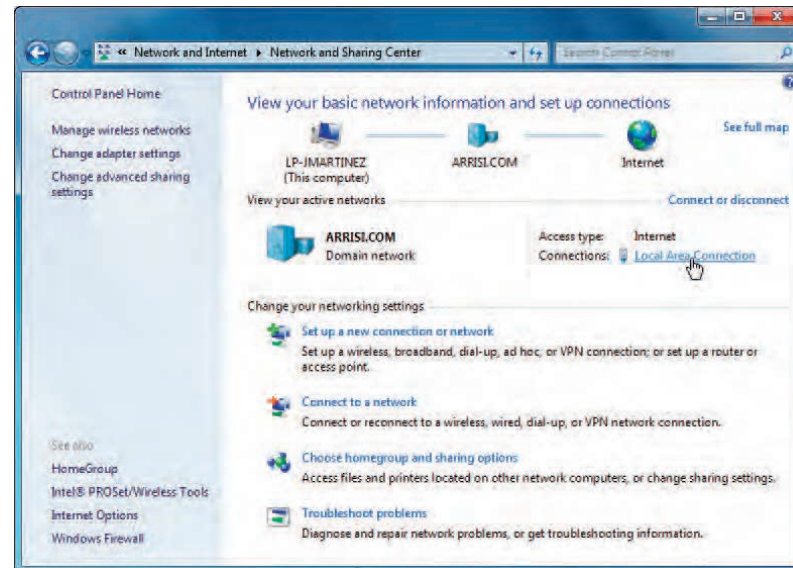
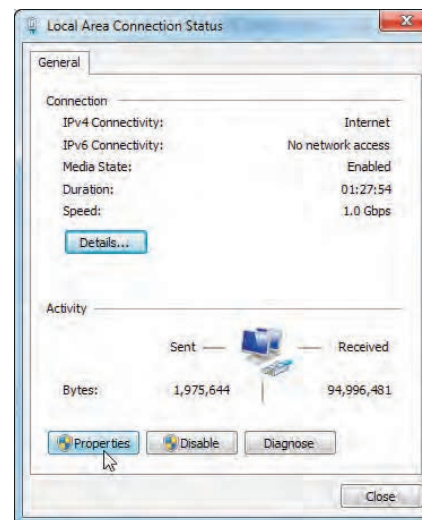
**3 Click Network and Sharing Center.****4 Click Local Area Connection to open the Status window.**

- 5 Click **Properties** to open the Properties window.

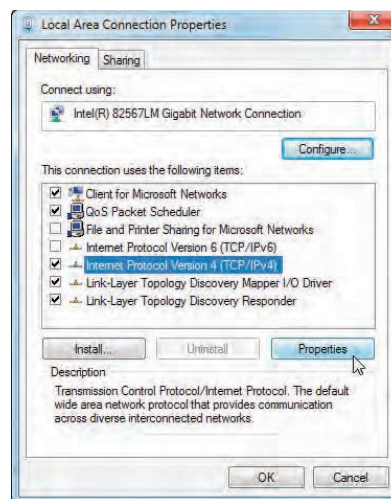

- 6 Select **Internet Protocol Version 4 (TCP/IPv4)** and click **Properties**.

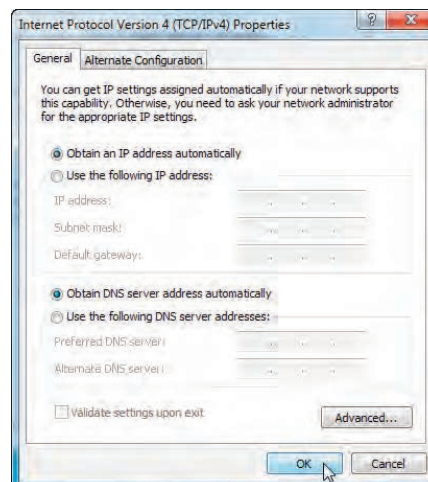

- 7 Select **Obtain an IP address automatically** and **Obtain DNS server address automatically**, unless instructed otherwise by your cable provider.
- 8 Click **OK** to close the Properties windows and then click **Close** to back out of the remaining setup screens.

## TCP/IP Configuration for MacOS X

Follow these steps to configure the Ethernet interface for use with Touchstone products.

- 1 Open System Preferences, either by choosing System Preferences from the Apple menu or by clicking the System Preferences icon in the dock.



2 Click the **Network** icon.

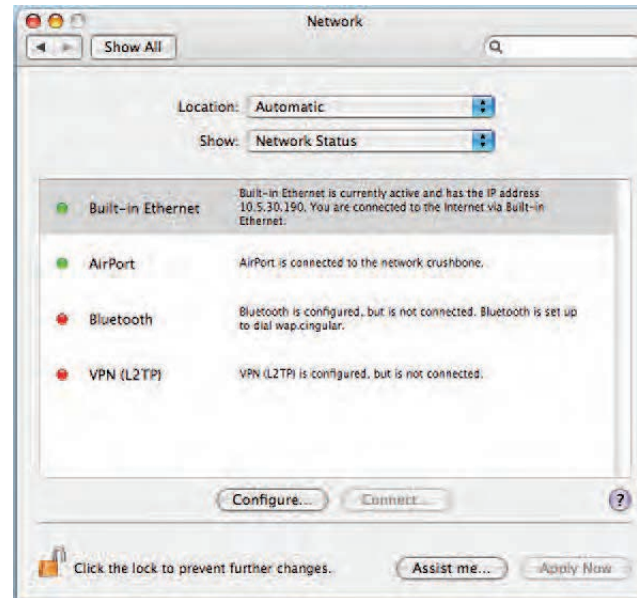



- 3 Choose **Automatic** from the Location drop-down menu, and **Built-in Ethernet** from the Show menu.

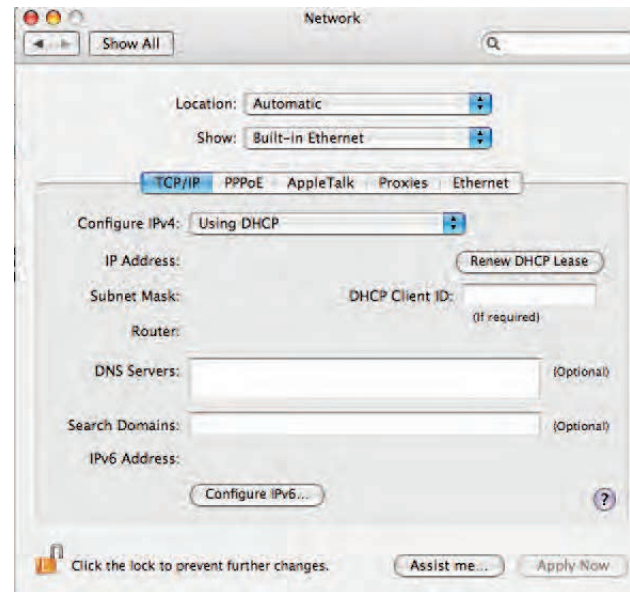

- 4 Choose the TCP/IP tab, if necessary.
- 5 Choose **Using DHCP** from the Configure IPv4 menu.
- 6 If necessary, click the **Renew DHCP Lease** button.
- 7 Close the System Properties application.

## Using the Telephony Modem

This chapter describes the controls and features available on the Touchstone Telephony Modem, and covers basic troubleshooting procedures.

- [Setting up Your Computer to Use the Telephony Modem](#)
- [Indicator Lights for the TM604G Models](#)
- [Using the Reset Button](#)
- [Booting from Battery](#)

### Setting up Your Computer to Use the Telephony Modem

Follow the instructions in the information packet supplied by your cable company. Contact your cable company if you need help setting up your computer.

### Indicator Lights for the TM604G Models

The Touchstone Telephony Modem has eight indicator lights to assist in troubleshooting. Note that not all models have a Battery light.

#### Battery Mismatch

If the Telephony Modem alternates flashing the Battery light and all other lights, the installed battery is incompatible with the Telephony Modem. Remove the battery and install one of the batteries described in [Battery Installation and Replacement \(TM604G Only\)](#).

## Wiring Problems

If the Telephony Modem begins flashing all its lights for more than 10 seconds, this indicates a problem with the telephone wiring—the red and green wires may be shorted (touching), or there may be undesired voltage on the lines. If this pattern persists for more than 10 seconds, disconnect the telephone lines from the Telephony Modem, then call a wiring technician for assistance.

## Indicator Lights: Normal Operation

The following table shows light patterns during normal operation.

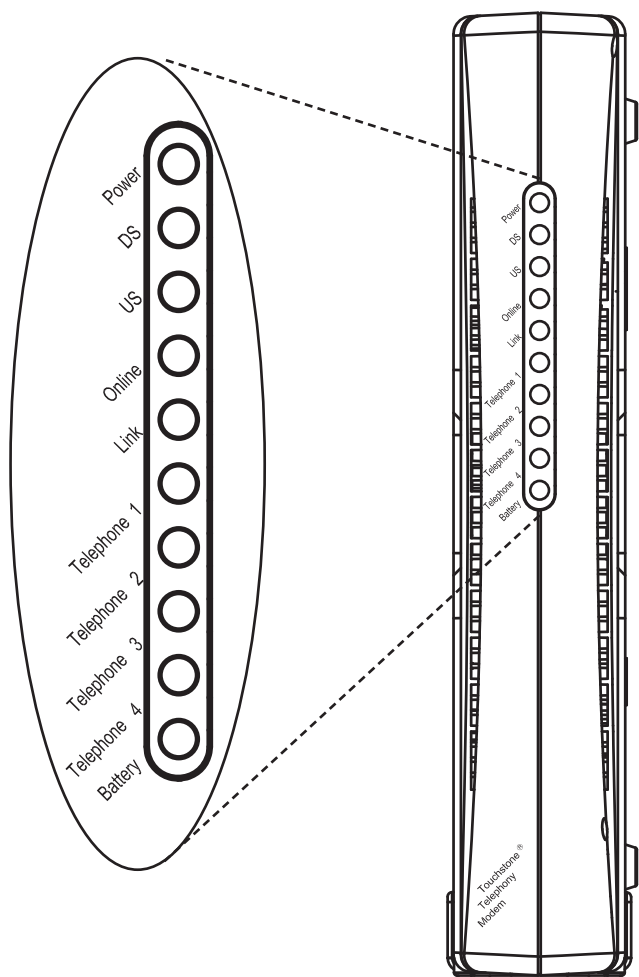

| Mode                             | Power     | DS   | US   | Online   | Link  | Tel. 1/<br>Tel. 2   | Battery   |
|----------------------------------|-----------|--|--|--|---|---|---|
| AC Power Good                    | <b>On</b> | <b>On</b> = Connected to the Internet<br>Flash = Not connected to the Internet | <b>On</b> = Connected to the Internet<br>Flash = Not connected to the Internet | <b>On</b> = Internet Available<br>Off = Internet not available | <b>On</b> = Computer Connected<br>Off = Computer not connected<br>Flash = Computer Activity | <b>On</b> = On-hook<br>Flash = Off-hook<br>Off = disabled | <b>On</b> = Battery good or low<br>Off = Battery missing or MTA not registered<br>Flash = Battery bad |
| No AC Power<br>Battery Installed | Flash     | Off  | Off  | Off  | Off   | <b>On</b> = On-hook<br>Flash = Off-hook<br>Off = disabled | Off = Battery power<br>Flash = Battery bad or low   |
| No AC Power<br>No Battery        | Off       | Off  | Off  | Off  | Off   | Off   | Off   |
| Firmware Upgrade                 | <b>On</b> | Flash  | Flash  | <b>On</b>  | (normal operation)  | (normal operation)  | (normal operation)  |

### Indicator Lights: Startup Sequence

The following table shows the Telephony Modem light patterns during each phase of the startup sequence. There are two phases of startup; the Telephony phase and the cable modem phase. Both are outlined below.

| Power,<br>DS, US,<br>Online   | Link      | Telephone |       | Battery* | Description                              |
|---|-----------|-----------|-------|----------|--|
|   |           | 1         | 2     |          |  |
| Off   | Off       | Off       | Off   | Off      | No power to Cable Modem                  |
| Flash   | Flash     | Flash     | Flash | Flash    | Power-on Self Test                       |
| See "Cable Modem Start Up Sequence" Below   |           |           |       |          |  |
| <b>On</b>   | <b>On</b> | Flash     | Off   | Off      | Retrieving telephone network information |
| <b>On</b>   | <b>On</b> | Off       | Flash | Off      | Retrieving telephone line information    |
| <b>On</b>   | <b>On</b> | Flash     | Flash | Off      | Activating telephone service             |
| Normal Operation<br>* = Battery LEDs only apply to those models with battery backup |           |           |       |          |  |

### Cable Modem Start Up Sequence

| DS        | US        | Online | Link | Description   |
|-----------|-----------|--------|------|---|
| Flash     | Off       | Off    | Off  | Downstream search   |
| <b>On</b> | Flash     | Off    | Off  | Downstream found; upstream search   |
| <b>On</b> | <b>On</b> | Flash  | Off  | Downstream and Upstream found; retrieving setup information from cable operator |

### Reset Button

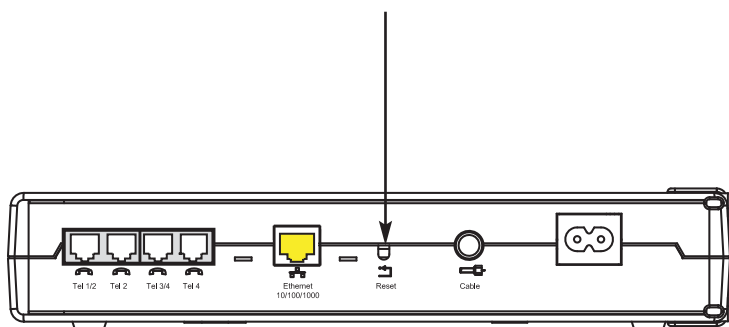

## Using the Reset Button

Use the **Reset** button, on the back of the Telephony Modem, to reset the modem as if you power cycled the unit. You may need to reset the Telephony Modem if you are having problems connecting to the Internet. Using this button will be rare.

Use a pointed **non-metallic** object to press this button. The photo to the left shows the location of the **Reset** button.

The **Reset** button is recessed to prevent accidental resets.

## Booting from Battery

The TM604 supports a "Boot from Battery" feature that allows the Telephony Modem to begin service without AC power.

To start the TM604 from its battery, follow these steps:

- 1 If a battery is already installed in the Telephony Modem, remove it.
- 2 Re-insert the battery into the Telephony Modem (see [Battery Installation and Replacement \(TM604G Only\)](#) for details).
- 3 Press the **Reset** button; the Power light should turn on immediately.

## Troubleshooting

### The Telephony modem is plugged in, but the Power light is off.

Check all power connections. Is the power cord plugged in firmly at both ends?

If you plugged the power cord into a power strip, make sure the strip is switched on.

Avoid using an outlet controlled by a wall switch, if possible.

Check the outlet by plugging in another device (such as a lamp).

Finally, check the fuse or circuit breaker panel.

### I'm not getting on the Internet.

It may take over 30 minutes to establish a connection the first time you power up your Telephony Modem, especially when many people are online. Always leave your Telephony Modem plugged into AC power and connected to the cable system.

Check the front panel lights:

- The **Power** and **Online** lights should be on.
- The **Link** light should be either on or blinking.
- If the **Power** light blinks for more than 30 minutes, call your cable company for assistance.

Check your cable connections. Connectors should be finger-tight. The [coax cable](#) should not be pinched, kinked, or bent sharply—any of these can cause a break or short in the cable (you may have to replace the cable). If you have one or more splitters between the Telephony Modem and CATV outlet, remove the splitters and connect the Telephony Modem directly to the outlet.

Proceed to the Ethernet solutions (next page) if necessary.

### **I'm not getting on the Internet. (Ethernet)**

If you are using a hub, is the hub turned on?

Are you using the right type of [Ethernet](#) cable? Use the supplied cable for direct connection to a computer; use a cross-over cable for connection to a hub or home router.

Press the **Reset** button on the back of the Telephony Modem.

### **I can get on the Internet, but everything is slow.**

If the Web site you are visiting is very popular, that site may be having trouble servicing all the requests. If other sites download quickly, wait for a few minutes and try again. Usage during peak hours may also affect the connection speed.

If your Telephony Modem is connected to a LAN (Local Area Network), either directly or through a firewall, other communications on the LAN may slow down your connection.

To test your network speed, try an online test such as [http://reviews.cnet.com/Bandwidth\\_meter/7004-7254\\_7-0.html](http://reviews.cnet.com/Bandwidth_meter/7004-7254_7-0.html)

### **I don't have dial tone when I pick up my phone, why?**

In order for telephone service to be functional on the Telephony Modem, telephone service must have been purchased from the service provider and configured on your Telephony Modem. The following steps should help in identifying the source of the problem.

- Is the **Power** LED lit?

If not, check to make sure the Telephony Modem is plugged in and the outlet has power.

If the LED is lit, go to the next step.

- Is the **Online** LED lit?  
If not, check the coax connection at the Telephony Modem and the wall. Ensure they are connected and tight. If they are and you do not have dial tone, contact your service provider.  
If the **Online** LED is lit, go to the next step.
- Is the **Telephone** (Telephone 1 or Telephone 2) LED lit?  
If not, phone service has not been provisioned on that line. Contact your service provider.  
If it is blinking, there is a phone off hook somewhere in the house. Find that phone and hang it up.  
If it is lit, go to the next step.
- Is the phone plugged directly into the Telephony Modem?  
Make sure the phone is plugged into the port on the back of the Telephony Modem labeled "Tel 1/2" (TM604G) or "Tel 1" (TM604A/B) for line 1, and "Tel 2" for line 2.  
If so, try a different phone. Make sure the new phone is a working phone.  
If a known good phone is used and you still don't have dial tone, try a different phone cable. If a new phone and cable do not restore dial tone, call your service provider.
- Is the Telephony Modem plugged into a wall outlet?  
If so, unplug the RJ-11 connector at the back of the Telephony Port and plug in a known working phone. If you now have dial tone, the problem is with the house wiring. Contact your MSO or a qualified wiring technician to correct the house wiring. If you still do not have dial tone, contact your service provider.



## Glossary

The following is a list of common cable and networking terms.

### **Amp-hour (Ah)**

A measure of battery capacity. For example, a 1.0Ah battery can nominally supply one Ampere of current for one hour.

### **Category 5 (Cat5)**

A high-quality type of cable, used for Fast Ethernet (100BaseT) connections. When purchasing Ethernet cables, always look for Category 5 cable.

### **Coaxial cable (coax)**

A thin wire, used to connect your television and Telephony Modem to the cable TV system. You can buy coax from any electronics retailer and many discount stores.

### **CPE**

Customer Premise Equipment. This is the equipment that is plugged in to the telephony modem; typically a computer, hub, or router.

### **Cross-over**

An Ethernet cable used to connect two hubs (or a hub and a cable modem) together. Also, some Ethernet hubs may have built-in cross-over on one or more ports (which eliminates the need for a cross-over cable).

### **DHCP**

Dynamic Host Configuration Protocol. An IP protocol used to provide an IP address and location of services (such as DNS and TFTP) needed by a device connecting to the network. DHCP allows the cable company to configure your computer's networking software for you.

### **DNS**

Domain Name Service (Server). An IP service that associates a domain name (such as www.example.com) with an IP address.

**Downstream**

In an HFC network, the direction from the head-end to the subscriber. Some older cable documentation may refer to this as the forward path.

**DOCSIS**

Data Over Cable System Interface Specification. The interoperability standards used for data communications equipment on an HFC network.

**EMTA**

Embedded Multimedia Terminal Adapter. An MTA device that is integrated with a cable modem.

**Ethernet**

A standard method of connecting two or more computers into a Local Area Network (LAN).

**Euro-DOCSIS**

The European version of DOCSIS.

**Event**

An informational message used for monitoring network status.

**F-connector**

The type of connector used on coax cable. There are two common types of F-connector, slip-on and screw-on. Use coax with screw-on connectors for connecting your Telephony Modem.

**Gateway**

The device, usually a router, that connects devices on a given IP subnet to other IP subnets.

**Headend**

The "central office" in an HFC network. The headend houses both video and data equipment. In larger cable networks, a "master" headend often feeds several "remote" headends to provide distributed services.

**HTTP**

HyperText Transfer Protocol.

**Hub**

A box with several Ethernet connectors. Ethernet hubs provide a common point of contact for all connected devices.

**IP address**

A number assigned to your computer by your cable company, used to identify your computer to other systems on the Internet.

**ISDN**

Integrated Services Digital Network. A digital telephony standard that provides communication speeds about twice as fast as standard dialup.

**LAN**

Local Area Network. A network that allows computers in a single location (such as a building) to communicate with one another.

**LED**

Light Emitting Diode. A semi-conductor diode that emits light when current is passed through it.

**MAC address**

A number that uniquely identifies any device connected to a network. Your cable company uses your Telephony Modem's MAC address to authorize access to the Internet. The MAC address is printed on a label on the bottom of your Telephony Modem.

**Protocol**

A set of rules and formats that determines the communication behavior of network entities at a given layer.

**Proxy**

A device or program that stands in between a server (for example, a web site) and a client (your browser), providing a way to relieve some of the burden from the server. For example, your cable company may have a web proxy that keeps copies of popular web pages; the proxy can send you those pages instead of fetching them directly from the web site, resulting in faster page loading and less network congestion.

**RF**

Abbreviation for Radio Frequency. Some literature refers to coax as “RF cable” and the connectors as “RF connectors.”

**RJ-11**

A standard 4-pin modular connector, commonly used in North America for connecting telephones.

**RJ-45**

A standard 6-pin modular connector, commonly used on Ethernet cable. An RJ-45 connector looks like a wide RJ-11 (telephone) connector.

**Splitter**

A small box with three cable connectors: one input and two outputs. You may need a splitter if you have a TV already connected to the cable outlet that you want to use for your Telephony Modem. You can buy a splitter from any electronics retailer and most discount stores.

**Switched outlet**

A power outlet that may be turned on and off using a wall switch. Usually intended for lamps. Avoid plugging your computer or Telephony Modem into a switched outlet to avoid disruptions.

**TCP/IP**

Transmission Control Protocol/Internet Protocol. The protocols used to facilitate communications across one or more connected networks.

**TDMA**

Time Division Multiple Access. A method used by DOCSIS-compliant cable modems for sending upstream data with minimal interference.

**Upstream**

The path from a subscriber device to the headend. Some older cable documentation may refer to this as the return path or reverse path.

# **Touchstone® TM604 Telephony Modem User's Guide**



©2005–2010 ARRIS Group, Inc. All rights reserved

All information contained in this document is subject to change without notice. ARRIS reserves the right to make changes to equipment design or program components, as progress in engineering, manufacturing methods, or other circumstances may warrant.

ARRIS, Touchstone, and the ARRIS logo are trademarks or registered trademarks of ARRIS Group. All other trademarks and registered trademarks are the property of their respective holders.

Protected under one or more of the following U.S. patents: 7,031,435; 7,100,011. Other patents pending.

ARSVD01097  
Release 6 Standard 1.3  
February 2010